

INSTALLATION AND OPERATING INSTRUCTIONS

LUX TX1500E Programmable Thermostat

WARNING: Use Energizer® or DURACELL® Alkaline Batteries Only. Energizer® is a registered trademark of Eveready Battery Company, Inc. DURACELL® is a registered trademark of The Gillette Company, Inc.



Mt. Laurel, New Jersey 08054, USA
<http://www.luxproducts.com>

52007

Thank you for your confidence in our product. To obtain the best results from your investment, please read these instructions and acquaint yourself with your purchase.

COMPATIBILITY

This thermostat can be used with most single stage 24 volt: gas, oil or electric heating and/or cooling systems, single stage heat pumps, or gas Millivolt heating systems. It cannot be used with 3-wire zone valves, 120 volt heating systems, or multi-stage heat pumps. Ask your dealer for other LUX thermostats to control those systems.

FEATURES

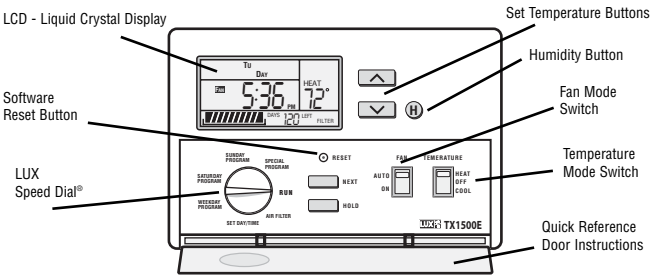

- Small elegant design
- Exclusive LUX Speed Dial®
- "EL" Illuminated Display
- Comprehensive Graphical Filter Monitor
- 5-1-1 Day Programming
- Energy Star Compliant
- 4 Periods Per Day
- Battery Free Memory Storage
- Temporary Temperature Override
- Temperature Hold
- Keyboard Lockout
- F/C Temperature Display
- 12/24 Hr Clock Display
- Adjustable Temperature Differential / Cycle Rate
- User Temperature Offset / Calibration
- System or Battery Powered
- 5/2 Minute Selectable Minimum Run/Off Time For Short Cycle and Compressor Protection

INSTALLATION

Please read ALL of these instructions carefully before beginning installation. Save them for future reference.

TOOLS REQUIRED

- #1 Phillips screwdriver
- Drill with 3/16 in. (4.8mm) bit
- Wire Stripper / Cutter

CAUTION: This thermostat is protected against normal minor static electric discharges, however to minimize the risk of damaging the unit in extremely dry weather, touch a grounded metal object before touching your thermostat.

LOCATION

On replacement installations, mount the new thermostat in place of the old one unless the conditions listed below suggest otherwise. On new installations, follow the guidelines listed below.

1. Locate the thermostat on an inside wall, about 5 ft. (1.5m) above the floor, and in a room that is used often.
2. Do not locate where air circulation is poor, such as in a corner or an alcove, or behind an open door.
3. Do not install it where there are unusual heating conditions, such as: in direct sunlight; near a lamp, television, radiator, register, or fireplace; near hot water pipes in a wall; near a stove on the other side of a wall.
4. Do not locate in unusual cooling conditions, such as: on a wall separating an unheated room; or in a draft from a stairwell, door, or window.
5. Do not locate in a damp area. This can lead to corrosion that may shorten thermostat life.
6. If painting or construction work has yet to be completed, cover the unit completely or do not install it.

WARNING:

- Read instructions carefully before removing any wires from your existing thermostat.
- Do not short (jumper) across the electric terminals on the furnace or air conditioner to test the system. This may damage the thermostat and void your warranty.
- This thermostat should be limited to 1.5 amps per terminal, and a maximum of 2 amps total; higher current than this may cause damage to the thermostat.
- All wiring must conform to the local codes and ordinances that are in your particular location.
- Your thermostat is a precision instrument, please handle it with care to avoid damage.

REMOVAL OF OLD UNIT

1. Turn OFF the electricity to all heating and cooling components. Do not turn the electricity back on until all work is completed.
2. Remove the cover and front portion of your old thermostat to expose the wiring connections.
3. Write down the letters printed near each wire terminal that is used, and the color of the wire that is connected to it. Using the enclosed labels, attach a label to each of your wires so that the letter matches the marking on your existing thermostat.
4. When they are all labeled, carefully remove the wires one at a time, making sure that they do not fall back inside the wall. Do not allow any of the bare wire ends to touch each other, or any parts on the thermostat.
5. Loosen all of the screws on the old thermostat and remove it from the wall.



MOUNTING

1. Strip insulation leaving 3/8 in. (9.5mm) bare wire ends and clean off any corrosion.
2. Fill wall opening with non-combustible insulation to prevent drafts from affecting the thermostat.

CAUTION:

Be careful not to drop the unit or disturb electronic parts. Leave the door closed while the body is being removed from the base.

3. Remove the body from the thermostat's base by pressing the thumb latch at the bottom center of the unit and swinging the body away.

NOTE:

If you are mounting the base to soft material like plasterboard or if you are using the old mounting holes, the screws may not hold. Drill a 3/16 in. (4.8mm) hole at each screw, and insert the plastic anchors provided.

4. Hold the base against the wall. Route the wires through the hole below the terminal block. Position the base for best appearance (to hide any marks from an old thermostat). Attach the base to the wall with the two screws provided.

CONNECTING THE WIRES

5. Wires must be trapped between the black clamps and the brass terminals as shown here.
6. Securely tighten all of the electrical terminal screws, including any unused ones.



NOTE:

When you are finished performing your installation and setup options, please remove the thin plastic film that is protecting the LCD display screen on the front of the thermostat. This plastic may or may not be present, and is evident by the appearance of fake digits appearing on the display screen.

WIRING INFORMATION

** Complete heating and/or cooling system wiring can be found in the WIRE IDENTIFICATION AND WIRING SCHEMATICS section of this instruction sheet. The schematics shown provide component information for brand new installations or for unreferenced wires.

SETUP OPTIONS

Install two new Energizer® or DURACELL® "AA" size alkaline batteries before continuing further. Ensure that the batteries are installed in the proper direction as per the markings shown in the battery tray.

NOTE:

All of the settings, options, and components listed in this section are located on the rear of the thermostat, on the circuit board.

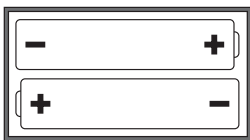

BATTERY COMPARTMENT

HARDWARE RESET

The hardware reset is a push button that is located on the right edge of the circuit board, just above the battery location. This reset button is used by the thermostat to reset the unit's clock, and read the position of all of the option switches. When any of the following items are changed, the hardware reset button must be pushed for the change to be recognized. User temperature programs are not erased when a hardware reset is performed.

FURNACE MODE

This is a plastic jumper cap which can be in one of two positions, GAS or ELECTRIC.

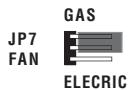

The Furnace Mode setting determines how the thermostat controls the fan operation. This setting has no effect in Cool Mode. While in Heat Mode, with the jumper in the Gas position, the fan is controlled by your furnace. With the jumper in the Electric position, the fan is controlled by the thermostat and is turned on when the heating terminal becomes energized.

The following option settings are all located within a group of small switches labeled 1 through 6 as shown below, and are located in the center of the circuit board.



[1] MINIMUM RUN DELAY

This sets the minimum length of time that the thermostat must remain with Heat or Cool either On or Off, before it will automatically switch to the alternate On or Off state. This feature prevents rapid cycling and provides compressor protection for cooling units. Switch position OFF is 5 minutes, and ON is 2 minutes.

[2] TIME FORMAT

This determines how the thermostat displays the clock and all other times on the screen. Switch position OFF is 12 HR, and ON is 24 HR.

[3] TEMPERATURE SCALE

This determines how the thermostat displays all temperatures on the screen. Switch position OFF is F°, and ON is C°.

[4] FILTER DISPLAY

This determines how the remaining filter life will be displayed on the filter bar graph at the bottom of the LCD screen. In the Percent (%) mode, the display will count down the percentage of air filter life remaining before a filter change is recommended. In the Days mode, the display will count down the number of calendar days remaining before a filter change is recommended. Either option will display the visual bar graph. Switch position OFF is Percent mode, and ON is Days mode.

[5] EARLY RECOVERY

Your thermostat has the ability to turn the Heating and Cooling in your home on early, so that it reaches your programmed "comfort" temperatures at the time you have set them for. For instance, if you have programmed your thermostat for 70° at 5:00pm, normally the thermostat would begin to heat your home back up at 5:00pm. With Early Recovery enabled, the thermostat will calculate the best time to turn the heat on so that the temperature in your home reaches 70° at or by 5:00pm. During the time that the thermostat is performing a recovery, the words "IN RECOVERY" will flash in the temperature portion of the display screen. Switch position OFF is Recovery Disabled, and ON is Recovery Enabled.

[6] BATTERY MONITOR

This determines whether the internal battery voltage monitor watches the condition of the batteries that are installed in the thermostat. This setting should always remain enabled unless the thermostat is being powered by System Power alone, without any batteries present. Switch position OFF is Battery Monitor On (Enabled), and Switch position ON is Battery Monitor Off (Disabled).

FRONT PANEL ITEMS

SOFTWARE RESET

The software reset is a small recessed push button that is located right above the NEXT button. This button can be pushed with a pencil or the end of a paper clip. This reset clears all of the heating and cooling programs, filter settings, and other user changeable preferences to their default values. You should write down your heating and cooling program times and temperatures prior to using the software reset.

MODE SWITCHES

There are two mode switches on the front, a Temperature mode switch and a Fan mode switch. The Temperature mode switch has three positions: HEAT, OFF, and COOL. In the winter, set the system switch to HEAT to control your heating system. In the summer, set the switch to COOL to control your air conditioner. In the spring and fall or when the windows are open, you can set the switch OFF. The Fan mode switch has two positions, AUTO and ON. Setting the Fan mode switch to AUTO, automatically runs your system's blower fan as required only during heating and cooling activation. Setting the Fan mode switch to ON, runs your system's fan continuously, even if heating or cooling is not needed, including when the Temperature mode switch is in the OFF position to provide air circulation only.

NOTE:

The Fan mode switch only works if your system provides a wire for the thermostat's "G" wire terminal.

PUSH BUTTONS

There are five primary push buttons on the front of the thermostat: The UP and DOWN arrow keys, the "H" humidity button, the NEXT button, and the HOLD button.

ROTARY DIAL

The LUX Speed Dial® provides an easy way to quickly navigate between the different programming areas. This rotary dial has seven individual positions.

OPERATING INSTRUCTIONS

SET DAY/TIME

Rotate the dial to the SET DAY/TIME position. You should see the word SET appear on the display, along with the clock and a day of the week that is flashing. With the day flashing, press the UP button to advance the day to the desired day. Press the NEXT button, this should cause the time to start flashing and the day to remain on steady. Using either the UP or DOWN buttons, adjust the clock to the desired time. The clock digits will increment rapidly if either the UP or DOWN buttons are held in the pressed position.

HEATING AND COOLING

Basic operation of your heating or cooling system can be obtained by ensuring that the rotary dial is in the RUN position, and simply moving the Temperature mode switch to either the HEAT or COOL position. Prior to being set initially with your custom temperature program, and also after a Software Reset, the thermostat will follow the default Energy Star® approved temperature routines that are preset within the thermostat's memory, as shown below.

PERIOD	HEAT MODE	COOL MODE
MORN	6:00 AM 70 °F (21 °C)	6:00 AM 78 °F (26 °C)
DAY	8:00 AM 62 °F (17 °C)	8:00 AM 85 °F (29 °C)
EVE	6:00 PM 70 °F (21 °C)	6:00 PM 78 °F (26 °C)
NITE	10:00 PM 62 °F (17 °C)	10:00 PM 82 °F (28 °C)

TEMPERATURE OVERRIDE

A Temperature Override occurs in Run mode, in either Heat or Cool, anytime the user adjusts the set temperature to a value that differs from the stored program temperature for that day and time. When the thermostat is in an Override, the word Override will appear in the temperature area of the display. The thermostat will maintain thermal control using this new set temperature, until the start of the next program period time is reached. At the start of the next program period, the set temperature will return to its programmed value. To enter an Override in either Heat or Cool mode, push either the UP or DOWN button once and the set temperature will begin to flash. Push either the UP or DOWN button to the new desired set temperature value. An Override may be cancelled by rotating the dial, changing the Temperature mode switch, or by initiating a Temperature Hold.

TEMPERATURE HOLD

A Temperature Hold is similar to an override, but is used for maintaining a constant set temperature for a longer time duration. Once a Hold is initiated, the thermostat will maintain the Hold set temperature indefinitely. A Temperature hold may be used for days, weeks, or even months at a time. To enter a Hold, push the HOLD button once, and the word Hold will appear in the temperature portion of the screen, along with the set temperature flashing. While the set temperature is flashing, push either the UP or DOWN button to the new desired set temperature value. To cancel a Hold, press and release the HOLD button once again, rotate the dial, or change the Temperature mode switch.

RELATIVE HUMIDITY

The "H" button on the front panel may be pressed to view the measured Relative Humidity in the vicinity of the thermostat. The Relative Humidity feature is available at all times, as long as the dial is in the RUN position.

AIR FILTER MONITOR

The Air Filter Monitor counts the number of days a filter has been in use since it has been replaced. In Run mode, the lower portion of the display graphically shows you the amount of time remaining before filter replacement is recommended. Next to the filter bar graph, there is a 3 digit numerical display of either Days Left, or Percent (%) Left, for filter life. CHANGE FILTER will appear when either the Days Left or the Percent Left numbers have reached zero and the filter should be changed. Days Over or Percent Over is indicated when a filter change is past due. To set and use the Air Filter Monitor, turn the dial to AIR FILTER. Use the UP or DOWN buttons and choose the number of days of filter life that your filter is rated for. Setting this value to OFF will disable the filter monitor and remove the filter bar graph from the display screen. Return the dial to the RUN position once you are finished setting the filter life.

RESET FILTER COUNTER

Once you have replaced your filter, the filter counter is reset back to a full bar graph and full amount remaining value by turning the dial to AIR FILTER and pressing the UP and DOWN buttons together at the same time. NOTE: The counter is also reset by changing the filter days setting value to a different number of days.

ADVANCED FEATURES

SPECIAL PROGRAM

When activated, the Special Program operates in much the same manner as the normal Weekday, Saturday, or Sunday program routines do, however the Special Program activation is temporary. The Special Program period times and temperatures can all be set to different values to accommodate a wide variety of usage circumstances that may occur, such as: home for a couple holiday days during the week, a vacation cut short, and so on. This feature eliminates the need to temporarily alter the settings for the existing Weekday, Saturday, or Sunday programming periods that will continue to be used most of the time. To activate the Special Program, press and hold down the HOLD button for a minimum of 2 seconds. When the Special Program is active, the words SPECIAL PROGRAM will be present in the upper left corner of the screen, and the clock will alternate with the Days Left value. Initially, upon activation, you can set the number of days that the Special Program will be controlling the set temperature. Use the UP/DOWN buttons to change the Days Left number to a value between 01 and 99 days. 01 Days Left is the default setting. If a selection is not made, the value of 01 days will be used.

SWING SETTING

A thermostat works by turning your heating or cooling system on and off whenever the room temperature varies from the set-point temperature. The amount of this variation is called the "swing." Your system should cycle on about 3 to 6 times per hour. A smaller swing number increases the number of cycles per hour, so the room temperature is more precise and constant. A larger swing number decreases the number of cycles per hour, but saves energy in most cases. To change the Swing setting, turn the dial to RUN mode. Hold down the NEXT button and push the HOLD button once, then let go of both. The words SWING and SET will appear on the screen with a number. Use the UP/DOWN buttons to change the number value between 1 and 9. Number 1 is the default setting. Press the NEXT button to accept the setting and return to normal Run mode.

TEMPERATURE CALIBRATION

The internal temperature sensor in this thermostat is accurately calibrated at the factory. The Temperature Calibration feature allows you to manually offset the measured temperature by as much as plus or minus 5°F (3°C) degrees from its original value. This feature can be useful to match this thermostat to another one or more, if multiple thermostats are used in the same home. To change the Temperature Calibration, turn the dial to RUN mode, and place the Temperature mode switch in the OFF position. Hold down the UP button and push the DOWN button once, then let go of both. The words CAL and SET will appear on the screen with a number. Use the UP/DOWN buttons to change the number value between -5°F (-3°C) and +5°F (+3°C) degrees. 0 degrees of correction is the default setting. Press the NEXT button to accept the setting and return to Run mode.

HUMIDITY CALIBRATION

The internal humidity sensor in this thermostat is accurately calibrated at the factory. The Humidity Calibration feature allows you to manually offset the measured humidity by as much as plus or minus 15% from its original value. This feature can be useful to match the displayed humidity to that of another humidity measurement device that you may have. To change the Humidity Calibration, turn the dial to RUN mode. Push the "H" button once to display the humidity. Hold down the UP button and push the DOWN button once, then let go of both. The words SET, CAL, and %RH will appear on the screen with a number. Use the UP/DOWN buttons to change the number value between -15 %RH and +15 %RH. 0% RH of correction is the default setting. Press the NEXT button to accept the setting and return to normal Run mode.

KEYLOCK

To prevent tampering with any of your settings or temperatures, most of the front panel buttons can be locked out by pressing the following four-button sequence: NEXT, NEXT, NEXT, HOLD. This sequence of keys will lock and also unlock these items: UP, DOWN, NEXT, HOLD, the Rotary Dial, and the Software Reset button. The "H" Humidity button, and both of the Mode slide switches are not locked out. When the Keylock is activated, a padlock icon will be visible in the area above the clock as shown below. The Keylock will be disabled if the Hardware Reset button is pressed.

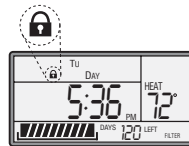

PROGRAMMING

For all of the programming areas that are described below, this thermostat provides four independent periods per day for Heat mode and Cool mode, they are: MORN, DAY, EVE, and NITE. Each period ends at the start time of the following period. The programs for each Temperature mode are programmed separately. When you perform a Software Reset, an Energy Star® approved program is inserted into all of the program periods. You can use these default programs or alter any portion of them to suit your own preferences. When setting the program items, the value that is flashing is the item that you can change at that time.

SET WEEKDAY PROGRAM

Select either HEAT or COOL with the Temperature mode switch. Rotate the dial to WEEKDAY PROGRAM. You will be programming all five weekdays at the same time. The first period is MORN. Using the UP and DOWN buttons, set the start time for this period, and then push the NEXT button to proceed. Now set the desired set temperature for the MORN period using the UP and DOWN buttons, and push NEXT to proceed. Now set the start time and set temperature for the DAY period, pushing NEXT after each to advance. Continue with these same steps to set the start time and set temperature for the EVE, and NITE program periods. When you are finished setting all four periods, you may continue pushing the NEXT button through all four periods to review your entries, or turn the dial to RUN if you are finished. These same programming steps for all four periods must be performed in both Heat and Cool Temperature modes independently.

SET SATURDAY PROGRAM

Turn the dial to SATURDAY PROGRAM. You will begin with the start time of the MORN period, and use the same procedures that were performed while setting the Weekday Program periods, using the NEXT button to advance through the values. Return the dial to the RUN position when you are finished.

SET SUNDAY PROGRAM

Turn the dial to SUNDAY PROGRAM. You will begin with the start time of the MORN period, and use the same procedures that were performed while setting the Weekday Program periods, using the NEXT button to advance through the values. Return the dial to the RUN position when you are finished.

SET SPECIAL PROGRAM

Turn the dial to SPECIAL PROGRAM. You will begin with the start time of the MORN period, and use the same procedures that were performed while setting the Weekday Program periods, using the NEXT button to advance through the values. Return the dial to the RUN position when you are finished.

BATTERIES AND MAINTENANCE

This thermostat can be powered either by "AA" alkaline batteries, by 24VAC system common power, or a combination of both. If you are using batteries alone, the batteries should be replaced AT LEAST once per year, or sooner if the LOW BAT battery symbol appears in the lower left portion of the display screen as shown below.

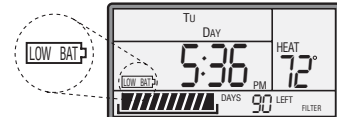

To replace the batteries in the thermostat, remove the thermostat's body from the base plate attached to the wall by pressing the thumb latch at the bottom center of the unit and swinging the body towards you, up and away from the base. Remove the used batteries from the battery tray and discard appropriately.

Install two new Energizer® or DURACELL®, "AA" size alkaline batteries into the battery tray. Observe the polarity markings shown in the battery compartment to ensure proper installation. When finished, hang the top of the unit by the tabs at the top corners of the base, then snap the bottom of the unit into place. Do not use unnecessary force. If the body does not snap into place easily, remove the body, re-hang it from the tabs and try again.

TECHNICAL ASSISTANCE

If you have any problems installing or using this thermostat, please carefully and thoroughly review the instruction manual. If you require assistance, please contact our Technical Assistance department at 856-234-8803 during regular business hours between 8:00AM and 4:30PM Eastern Standard Time, Monday through Friday. You can also receive technical assistance online anytime day or night at <http://www.luxproducts.com>. Our web site offers you answers to the most common technical questions, and also permits you to email your questions to our technical support staff at your convenience.

WARRANTY

Limited Warranty: If this unit fails because of defects in materials or workmanship within three years of the date of original purchase, LUX Products Corporation will, at its option, repair or replace it. This warranty does not cover damage by accident, misuse, or failure to follow installation instructions. Implied warranties are limited in duration to three years from date of original purchase. Some states do not allow limitations on how long an implied warranty lasts, so the above limitation may not apply to you. Please return malfunctioning or defective units to the participating retailer from which purchase was made, along with proof of purchase. Please refer to the "TECHNICAL ASSISTANCE" section before returning thermostat. Purchaser assumes all risks and liability for incidental and consequential damage resulting from installation and use of this unit. Some states do not allow the exclusion of incidental or consequential damages, so the above exclusion may not apply to you. This warranty gives you specific legal rights and you may also have other rights which vary from state to state. Applicable in the U.S.A. only.

ENGLISH - WIRE IDENTIFICATION AND WIRING SCHEMATICS

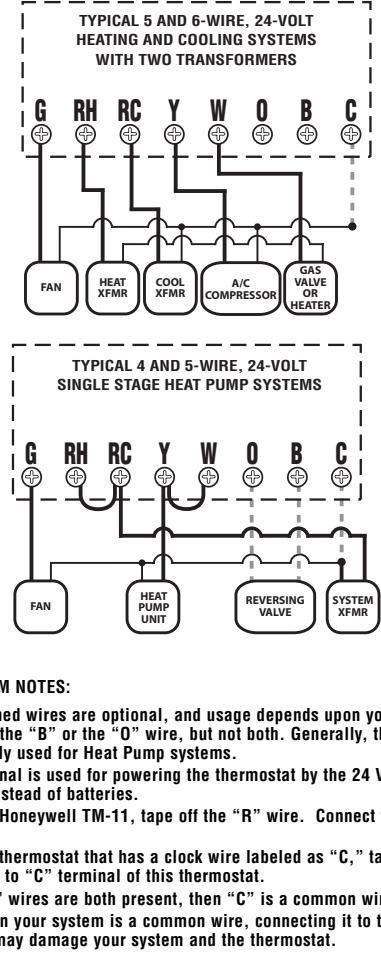
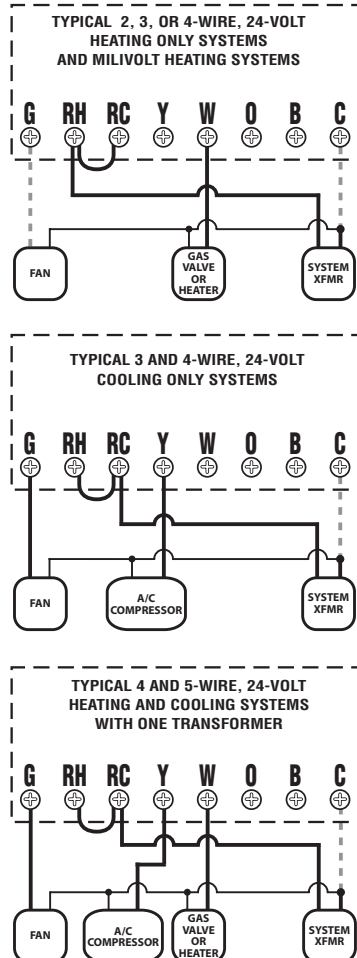
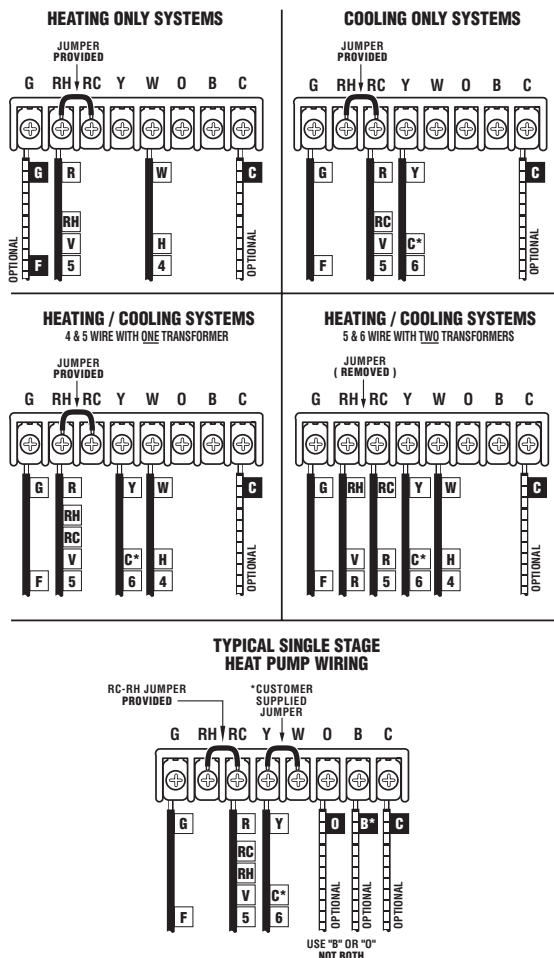

- WIRING DIAGRAM NOTES:**
- All of the dashed wires are optional, and usage depends upon your specific system type. Use either the "B" or the "O" wire, but not both. Generally, the B and O terminals are only used for Heat Pump systems.
 - The "C" terminal is used for powering the thermostat by the 24 Volt system power in addition to, or instead of batteries.
 - If replacing a Honeywell TM-11, tape off the "R" wire. Connect the "B" wire to the "RH" terminal.
 - If replacing a thermostat that has a clock wire labeled as "C," tape off this wire and do not connect it to "C" terminal of this thermostat.
 - If "Y" and "C" wires are both present, then "C" is a common wire.
 - If a "B" wire in your system is a common wire, connecting it to the "B" terminal of this thermostat may damage your system and the thermostat.

FRANÇAIS – IDENTIFICATION DES FILS ET SCHÉMAS DE CÂBLAGE

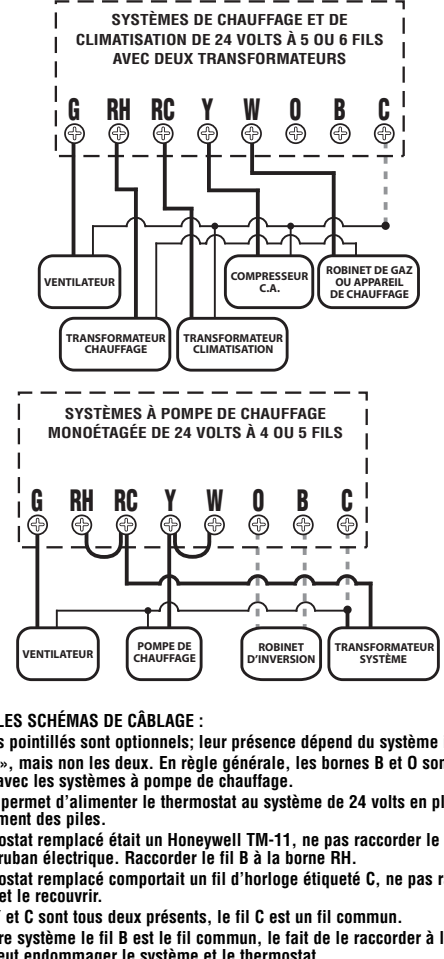
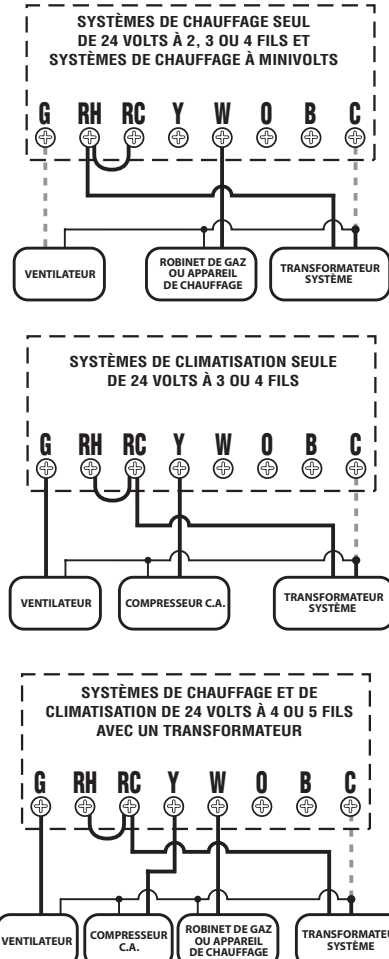
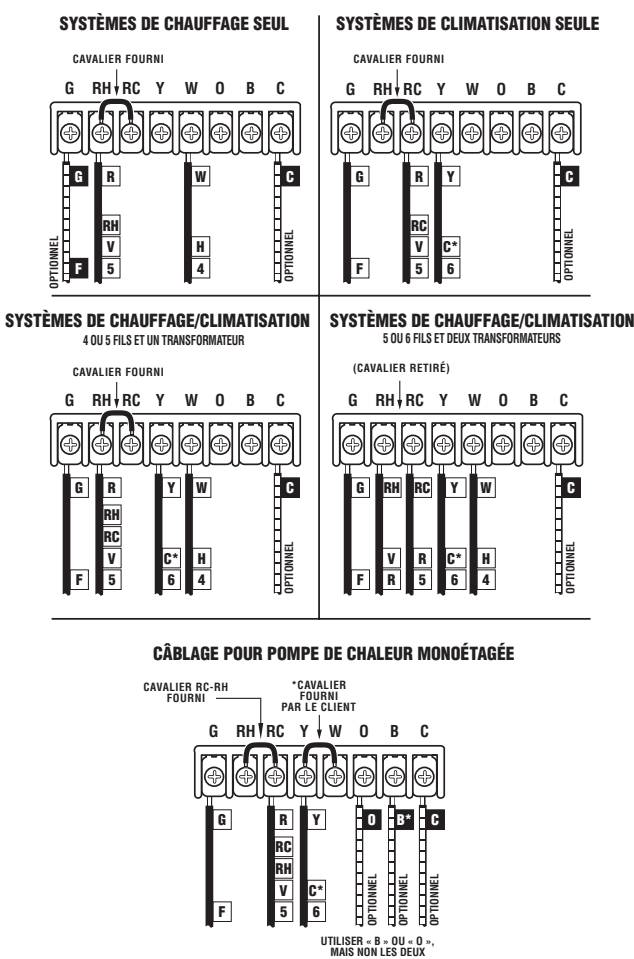

- NOTES SUR LES SCHÉMAS DE CÂBLAGE :**
- Tous les fils pointillés sont optionnels; leur présence dépend du système installé. Utiliser « B » ou « O », mais non les deux. En règle générale, les bornes B et O sont utilisées uniquement avec les systèmes à pompe de chauffage.
 - La borne C permet d'alimenter le thermostat au système de 24 volts en plus des piles, ou en remplacement des piles.
 - Si le thermostat remplacé était un Honeywell TM-11, ne pas raccorder le fil R et le recouvrir de ruban électrique. Raccorder le fil B à la borne RH.
 - Si le thermostat remplacé comportait un fil d'horloge étiqueté C, ne pas raccorder le fil C à la borne C et le recouvrir.
 - Si les fils Y et C sont tous deux présents, le fil C est un fil commun.
 - Si dans votre système le fil B est le fil commun, le fait de le raccorder à la borne B de ce thermostat peut endommager le système et le thermostat.

ESPAÑOL – IDENTIFICACION DE CABLES Y DIAGRAMAS DE CABLEADO

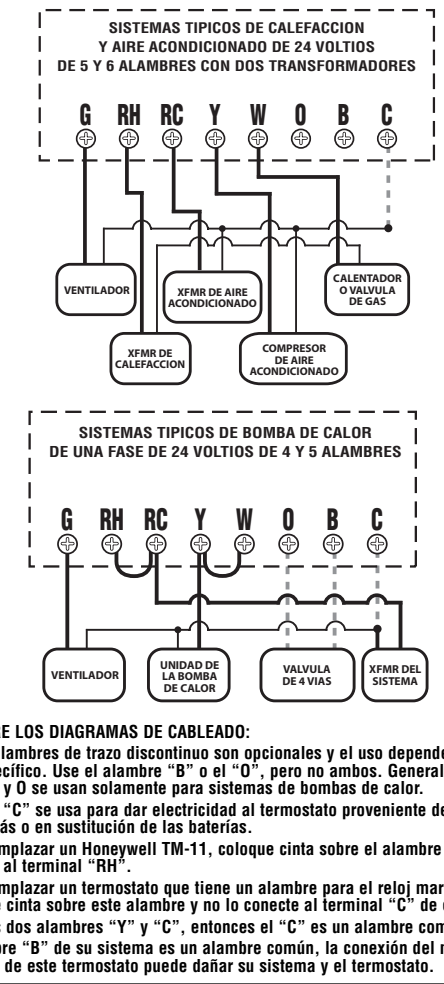
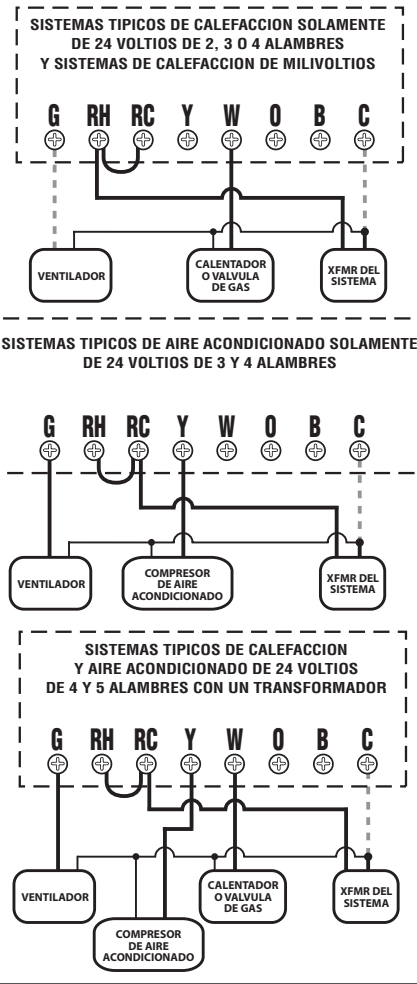
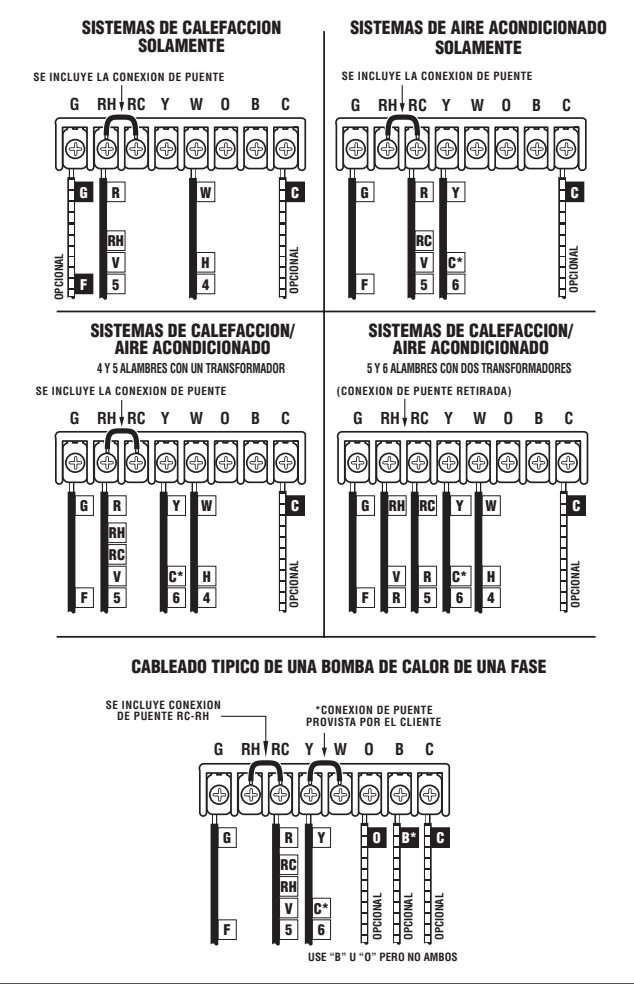

- NOTAS SOBRE LOS DIAGRAMAS DE CABLEADO:**
- Todos los alambres de trazo discontinuo son opcionales y el uso depende del tipo de su sistema específico. Use el alambre "B" o el "O", pero no ambos. Generalmente, los terminales B y O se usan solamente para sistemas de bombas de calor.
 - El terminal "C" se usa para dar electricidad al termostato proveniente del sistema de 24 voltios además o en sustitución de las baterías.
 - Si va a reemplazar un Honeywell TM-11, coloque cinta sobre el alambre "R". Conecte el alambre "B" al terminal "RH".
 - Si va a reemplazar un termostato que tiene un alambre para el reloj marcado con una "C," coloque cinta sobre este alambre y no lo conecte al terminal "C" de este termostato.
 - Si tiene los dos alambres "Y" y "C," entonces el "C" es un alambre común.
 - Si el alambre "B" de su sistema es un alambre común, la conexión del mismo al terminal "B" de este termostato puede dañar su sistema y el termostato.